

Flow synthesis of organic azides and the multistep synthesis of imines and amines using a new monolithic triphenylphosphine reagent†

Catherine J. Smith, Christopher D. Smith, Nikzad Nikbin, Steven V. Ley and Ian R. Baxendale

Received 1st October 2010, Accepted 22nd November 2010

DOI: 10.1039/c0ob00813c

Here we describe general flow processes for the synthesis of alkyl and aryl azides, and the development of a new monolithic triphenylphosphine reagent, which provides a convenient format for the use of this versatile reagent in flow. The utility of these new tools was demonstrated by their application to a flow Staudinger aza-Wittig reaction sequence. Finally, a multistep aza-Wittig, reduction and purification flow process was designed, allowing access to amine products in an automated fashion.

Introduction

Recently, there has been considerable interest in the utilisation of flow based techniques for laboratory scale chemical synthesis.¹ The general aim has been the design of flow processes that permit efficient assembly of small molecules in useful quantities for biological evaluation, and that also allow facile scale-up of resulting hit compounds.²

These flow procedures are defined by high standards of safety, efficiency, reproducibility and product purity. Further benefits can be realised when flow processing is conducted with the use of solid supported reagents³ that aid work-up/purification and make telescoped multistep sequences more readily achievable.⁴ With advances in commercially available benchtop flow chemistry platforms and associated technologies for reaction monitoring, flow processing has become an increasingly viable tool for all synthesis scales; not only for industrial production processes but also for small research laboratories. Chemists can now consider designing highly automated multistep processes, including the use of in-line purification strategies to deliver high quality products in a safe and efficient manner.⁵

While the use of flow processing for laboratory scale chemical synthesis offers some advantages, it also entails its own unique set of challenges. For the generation of a collection of compounds in flow, syntheses are often carried out in a series of short reaction plugs. This processing method, whereby reaction plugs are passed through the flow system in a constant stream of solvent, is termed segmented flow. The continuous flow processing generally employed for larger scale syntheses operates under steady state conditions. Working in segmented flow, however, means that over the course of each reaction, conditions at a given point in the

reactor only briefly reach steady state. These conditions make operations such as the introduction of a third reaction component or later stage combination of two intermediates much more technically challenging.

To date, the most common solution to this ‘third stream problem’ in segmented flow processes has been to use the third stream component in excess, necessitating substantial in-line or off-line purification.^{6,7} This strategy may be acceptable in some cases, but leaves significant room for improvement in terms of both process safety and efficiency, particularly when the third stream reagent is toxic or includes precious material. However, until the technology to effect precise monitoring and control over flow reactions on laboratory scale is widely available,⁸ this problem is best solved using very specific chemical strategies. The challenges of segmented flow processes render the use of supported reagents and techniques such as catch-and-release and catch-react-and-release vital components of the flow chemist’s toolbox.⁹

One such approach is the Staudinger aza-Wittig reaction, which has been previously employed as a key bond forming reaction in our flow synthesis of the natural product oxomaritidine.¹⁰ Using supported triphenylphosphine, the Staudinger aza-Wittig reaction is a particularly powerful method for the formation of imines^{10,11} within a multistep segmented flow process. Trapping an *in situ* generated azide as the iminophosphorane on the solid support allows facile purification of this intermediate, provides an opportunity for solvent switching if desired, and enables subsequent reaction with an *in situ* generated aldehyde with controlled stoichiometry. This entire process can be conducted without any manual handling or isolation of potentially hazardous or sensitive reaction components.

Despite the strategic value of this transformation, it has not found wider application in our other synthetic programmes due to the nature of the polymer-supported reagents involved. Commercially available sources of azide ion exchange resin and polymer-supported triphenylphosphine are supplied as low cross-linked microbead formats, which can be difficult to employ in a flow environment owing to their solvent-swelling characteristics

Innovative Technology Centre, Department of Chemistry, University of Cambridge, Lensfield Road, Cambridge, UK CB2 1EW. E-mail: theitc@ch.cam.ac.uk

† Electronic supplementary information (ESI) available. CCDC reference numbers 791578, 791581. For ESI and crystallographic data in CIF or other electronic format see DOI: 10.1039/c0ob00813c

and the resulting high pressure. An additional restriction to their wide-scale adoption is the prohibitive financial cost of these commercial materials.

Our group and others have been interested in expanding the range of solid-supported reagents available, and have been investigating the benefits of new polymeric support materials for application in flow synthesis.¹² Monolithic columns are an interesting and effective format for supported reagents, as they offer a more convenient physical form for handling and improved flow characteristics, whilst retaining the benefits of traditional beads.¹³ Of further importance is the ability to rapidly synthesise bespoke monolithic reagents without any specialist equipment or techniques such as those required for the manufacture of traditional bead type reagents. This is an especially attractive concept for the preparation of customised alternatives to expensive and/or non-reusable supported reagents, and allows tailoring of the monolith to suit a particular application. We have recently reported the development of an azide ion-exchange monolith, which was successfully used to generate acyl azides for use in the Curtius rearrangement.¹⁴ Here we report the development of a new monolithic triphenylphosphine reagent and improved processes for the flow synthesis of alkyl and aryl azides. With these superior reagents and processes in hand, we return to the study of the Staudinger aza-Wittig reaction, and demonstrate its utility for compound library synthesis and finally for its application in the multistep automated synthesis of amines under flow conditions.

Results and discussion

All flow reactions and monolith preparations described in this work were conducted using the commercially available Vapourtec R2+/R4 flow system and automated sequences controlled by Flow Commander software.¹⁵

Flow synthesis of alkyl azides

During our flow synthesis of oxamaritidine,¹⁰ we reported the generation of alkyl azides from alkyl bromides using commercially available azide ion exchange resin, a costly reagent with some undesirable characteristics for use in flow. However, this process can be greatly improved using the azide ion exchange monolith recently developed by our group,¹⁴ as shown in Scheme 1.

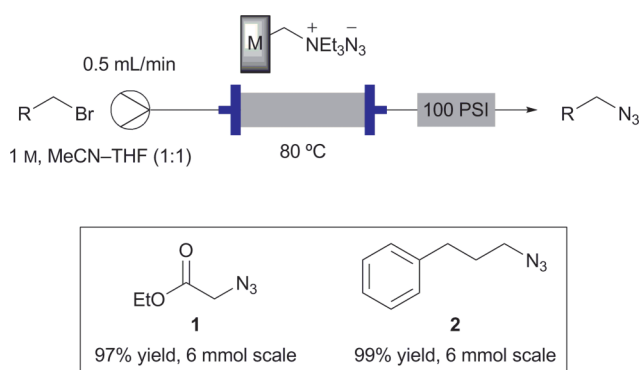

Scheme 1 Flow synthesis of alkyl azides.

The monolithic reagent was used in excess (13 mmol supported azide used for up to 10 mmol of reaction) to ensure complete

and rapid conversion to the desired azide products. Fully or partially depleted monoliths could be regenerated, and were found to function with the same performance for multiple cycles of regeneration and use. Alkyl bromides (1 M in MeCN-THF 1 : 1) were pumped at a flow rate of 0.5 mL min⁻¹ through an azide ion-exchange monolith heated to 80 °C, generating the corresponding alkyl azides in high yields and purities following only evaporation of solvent. These azides could either be isolated as final products or carried on without isolation as intermediates in a multistep flow sequence as described below.

Flow synthesis of aryl azides

The utility of the Staudinger aza-Wittig reaction as a general tool for application in multistep segmented flow processes would be greatly enhanced by expanding the substrate scope of our flow procedure to include aryl azides. Aryl azides are useful compounds with a wide variety of applications in chemistry, biology and materials science.¹⁶ Given the importance of these compounds and the hazards associated with their generation and handling, a general flow process for the synthesis of aryl azides would find widespread application in a variety of fields. Until very recently,⁷ however, there was no protocol reported for the synthesis of aryl azides in flow. Therefore, building on our previous experience^{10,17} and initial investigations in this area,¹⁸ we set out to develop a flow process for the synthesis of aryl azides, and to demonstrate its utility in multistep segmented flow sequences.

We chose to use the mild and efficient batch conditions developed by Moses and coworkers¹⁹ as a convenient starting point for the development of a flow process. Simply carrying out these same reactions in flow would eliminate the need to cool (and even allow safe heating of) these reactions, and would address the issues of handling dangerous materials and gas evolution on scale. However, in our view, the original batch conditions still required further optimisation to provide an ideal flow process for application to chemical library and multistep syntheses. Our principle goals were to avoid using any excess of potentially hazardous components, in this case, toxic trimethylsilyl azide, and to develop one set of general conditions that could be applied to a wide range of substrates. Furthermore, it was of critical importance to include in-line purification strategies (two different strategies were employed, as discussed in this and the following publication²⁰) to ensure that no hazardous starting materials or by-products were carried through into later steps.

Initial optimisation indicated that it was possible to carry out these reactions with only one equivalent each of *tert*-butyl nitrite and trimethylsilyl azide. Indeed, Moses and co-workers subsequently reported these reactions with 1 : 1 : 1 stoichiometry,²¹ but noted that reaction times required under these conditions varied from 2 min for 4-nitroaniline to 16 h for aniline. By carrying out these reactions in flow, however, we were able to heat reactions in order to effect good conversions for all substrates tested in a standard reaction time of 50 min.

Using the general flow conditions shown in Scheme 2, we were able to obtain high conversions (86–95%) to the desired azide products from aniline starting materials with a wide range of electronic and steric demands (Table 1). For each reaction the azides were obtained in very good purities, with the only detectable contaminants being traces of unreacted starting materials, which

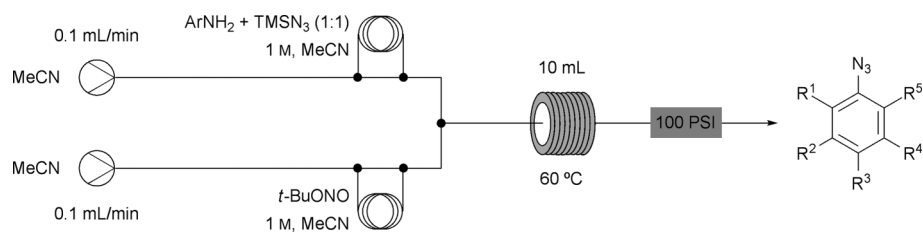

Scheme 2 Flow synthesis of aryl azides.

Table 1 Aryl azides generated in flow

Entry	R ¹	R ²	R ³	R ⁴	R ⁵	Conversion ^a
1	H	H	H	H	H	94%
2	H	H	Me	H	H	94%
3	H	H	OMe	H	H	95%
4	H	H	NO ₂	H	H	93%
5	H	H	CO ₂ Me	H	H	86%
6	I	H	H	H	H	86%
7	<i>i</i> Pr	H	H	H	H	93% (72%) ^b
8	COMe	H	H	H	H	89% (75%) ^b
9	Cl	H	Cl	H	H	91%
10	CN	H	Br	H	H	87% (88%) ^b
11	H	C≡CH	H	H	H	92%
12	H	OMe	H	H	H	91%
13	H	CF ₃	H	CF ₃	H	89%

^a Reactions were carried out as shown in Scheme 2, on a 1 mmol scale. Conversions are based on the ratio of azide product to aniline starting material as determined by ¹H NMR. ^b Isolated yields after column chromatography. (Low yields for Entries 7 and 8 may be due to volatility of these products.)

could be removed prior to further reaction either by a catch-react-and-release strategy as described below, or by in-line scavenging as discussed in the following publication.²⁰ Furthermore, these reactions could be safely scaled with no modification to the procedure; for the work discussed here azides were generated on up to 10 mmol scale.

Mechanistic investigation

A recent publication⁷ has suggested that, by analogy to the iododeamination of anilines with *tert*-butyl nitrite,²² the generation of aryl azides under similar conditions also proceeds *via* an aryl radical intermediate. However, the mechanism of aryl azide formation from diazonium salts and azide ions has been extensively studied, and it is generally agreed that this reaction progresses *via* pentazene and pentazole intermediates formed by attack of the azide species on the terminal nitrogen of the diazonium.^{16,23} Under our reaction conditions, it is not necessarily clear which of these mechanistic pathways would be favoured. While these reactions do involve heating anilines with *tert*-butyl nitrite, in the presence of trimethylsilyl azide we expected that azide formation would proceed *via* the precedented pentazene/pentazole mechanism, rather than the proposed radical pathway. Therefore we carried out two reactions involving labelled substrates in order to determine whether the aniline C–N bond is cleaved under our reaction conditions.

In our first experiment, we subjected (¹⁵N)aniline to the general conditions shown in Scheme 2. This resulted in the formation of (¹⁵N)azidobenzene as a single product. The identity of this material

[including position of the labelled nitrogen] was confirmed by two-dimensional NMR studies, as well as by comparison to previously reported IR and NMR data for (1-¹⁵N)-azidobenzene.²⁴ In a second experiment, we performed the same reaction beginning with a 1 : 1 mixture of *d*₅-aniline and (¹⁵N)aniline. Analysis of the reaction output identified *d*₅-azidobenzene and (¹⁵N)azidobenzene as the only products, indicating that no crossover between the two labelled substrates had occurred. From these experiments, we conclude that under our reaction conditions, aryl azide formation proceeds without cleavage of the aniline C–N bond, in agreement with the pentazene mechanism.

Generation of monolithic triphenylphosphine reagent

Triphenylphosphine is a commonly used laboratory reagent with a wide range of applications, but is notorious for causing purification difficulties, usually requiring expensive and time-consuming column chromatography to remove triphenylphosphine and its oxide by-product from the final product. Thus, it is highly desirable to use a supported version of triphenylphosphine, which can be easily removed at the end of the reaction. The current commercially available supported triphenylphosphine species are non-optimal, both in terms of handling in a flow system and their inherent cost. Here we report the development of a new monolithic triphenylphosphine reagent and its application to promote the Staudinger reaction in flow.

For monolith polymerisation, the monomer, cross-linker, porogen and initiator were homogenised and decanted into a glass column, which was then sealed at both ends and heated using the Vapourtec R4 multi-channel convection heater. Following polymerisation, the monolith could be connected to the flow system for washing and subsequent reactions, simply by exchanging the sealed ends of the column with standard tubing connectors.

For the work described here, monoliths were formed using a polymerisation mixture containing (weight% of total): 31.7% styrenediphenylphosphine (SDP) monomer, 24.9% divinylbenzene cross-linker, 42.7% 1-dodecanol porogen, and 0.7% 4,4'-azobis(4-cyanovaleric acid) (ACVA) initiator. In practice, SDP was dissolved in 1-dodecanol with gentle heating (>50 °C), then divinylbenzene was added, followed by ACVA, and the resulting mixture was loaded into a glass column. The polymerisation process was carried out by heating the sealed column at 90 °C in the R4 convective heating unit for 20 h. Following the polymerisation procedure, the monolith was washed with dry THF at 60 °C to elute the porogen and any residual non-polymeric material; this yielded a rigid white monolith that completely filled the glass column as shown in Fig. 1.

The monoliths used for this work were formed in 7 cm length × 10 mm i.d. columns, resulting in monoliths of 3 g



Fig. 1 Monolithic triphenylphosphine reagent, with and without glass column housing.

average dry weight. Elemental analysis indicated an average loading of 1.7 mmol phosphorous per gram of monolith. Loading of phosphorous was found to be consistent from monolith to monolith, and analysis of samples taken from various points along the length and radius of a single monolith revealed even distribution of phosphorous within the monolith.

An important practical consideration for the application of a fixed bed reactor in flow is the pressure drop created by the static bed. In testing, our triphenylphosphine monoliths demonstrated a near-linear correlation of flow rate and pressure, giving consistently low backpressures of only 2–4 bar (THF at a flow rate of 1.0 mL min⁻¹) when connected in-line. This low pressure drop made them ideal for use as in-line reactor cartridges, either on their own or in combination with additional cartridges.

Staudinger aza-Wittig Reaction in Flow

With these improved reagents and processes in hand, we turned our attention to their application in the Staudinger aza-Wittig reaction. The overall reaction sequence is shown in Scheme 3. First, the Staudinger reaction was carried out by heating the triphenylphosphine monolith to 60 °C using the R4 convection heater and passing a solution of organic azide through the

monolith at a flow rate of 0.15–0.2 mL min⁻¹. As shown in Scheme 4, azide starting materials could be isolated following batch or flow synthesis and introduced *via* the sample loop of the R2+ unit (Method A), however, a far superior method in terms of both safety and efficiency was to utilise azides generated in flow without isolation.

Indeed, both alkyl (Scheme 4, Method B) and aryl (Scheme 4, Method C) azides could be generated and carried on directly into the Staudinger reaction within the flow system simply by incorporating a triphenylphosphine monolith prior to the exit of the flow system. This required no modification to the procedure for the synthesis of aryl azides described above, although alkyl azides were generated at a reduced flow rate of 0.2 mL min⁻¹ to ensure adequate reaction time for the subsequent Staudinger reaction. Following the Staudinger reaction, the desired iminophosphorane intermediates were immobilised on solid support, allowing any excess azide or other impurities to be washed to waste (Scheme 3, Step 2). This simple purification step yielded the desired iminophosphoranes as pure and stable products on the monolithic support, which could be used immediately for further reactions, or stored in sealed columns on the benchtop for several weeks before use.

With a clean iminophosphorane monolith in hand, the aza-Wittig reaction was carried out by heating the monolith to 120 °C and passing through a solution of aldehyde or ketone (0.1–1.0 M in THF or MeCN–THF 1 : 1) at a flow rate of 0.1 mL min⁻¹ (Scheme 3, Step 3). It was found that each iminophosphorane monolith could be used for multiple reactions with different substrates without cross-contamination, simply by washing the monolith with the reaction solvent between runs. Furthermore, we found that repeated heating and cooling cycles did not affect the stability of the monoliths or purity of the resulting products.

In order to achieve high conversions of the desired imine products, the iminophosphorane monoliths needed to be used in an excess stoichiometry. Elemental analysis indicated an average loading of 5.1 mmol phosphorous per monolith. However, the

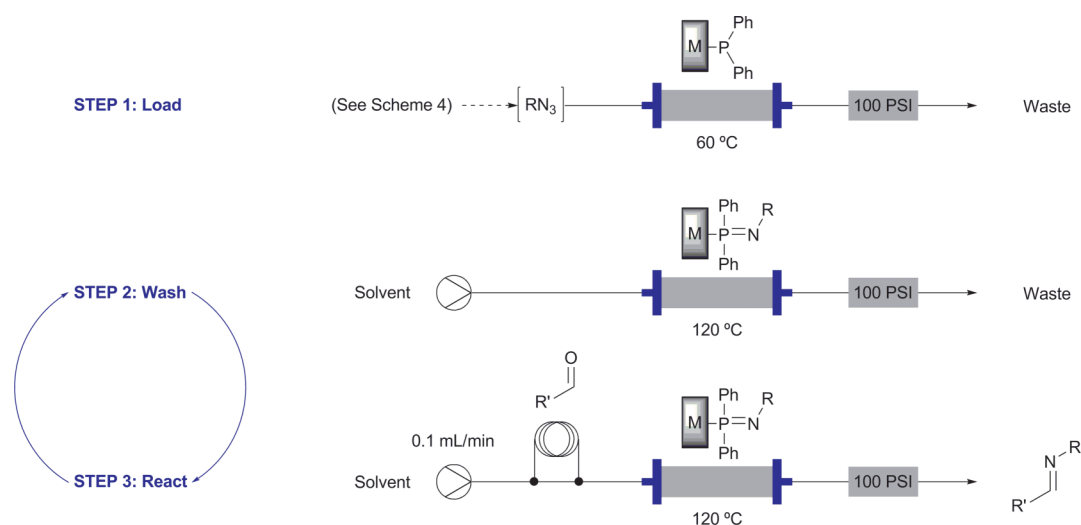

Scheme 3 Overall reaction sequence for Staudinger aza-Wittig reactions in flow. *Step 1:* Azides were loaded onto the triphenylphosphine monolith *via* the Staudinger reaction (see Scheme 4 for detail). *Step 2:* Washing with the appropriate solvent allowed removal of any impurities to provide a clean iminophosphorane intermediate on support. *Step 3:* Aza-Wittig reactions were carried out by passing a solution of aldehyde or ketone through the iminophosphorane monolith. Multiple sequential aza-Wittig reactions could be carried out using the same iminophosphorane monolith by washing with the appropriate solvent after each reaction.

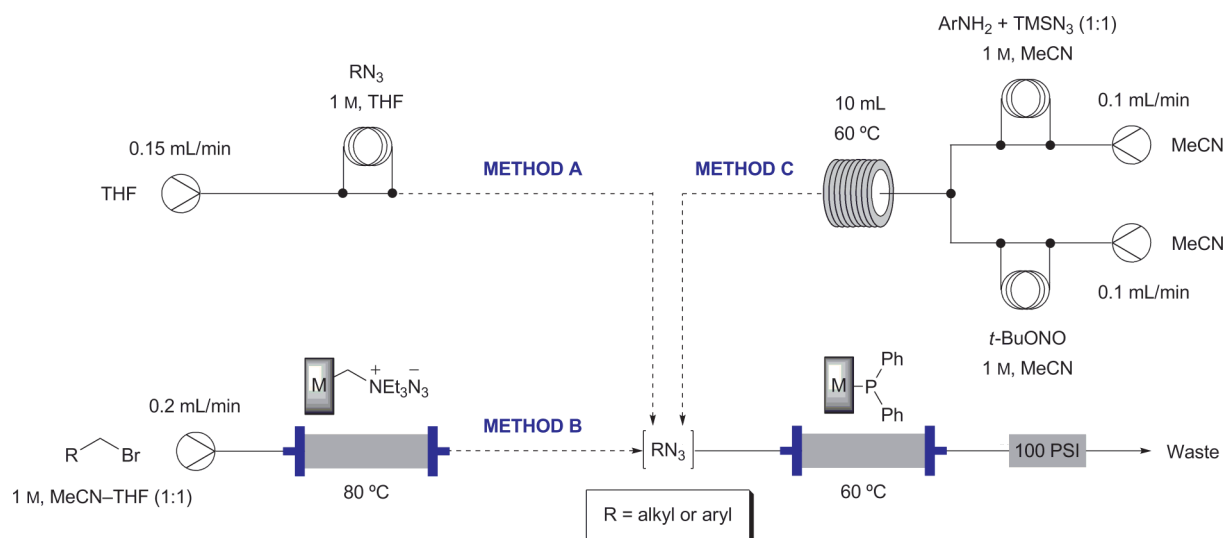

Scheme 4 Staudinger reaction in flow. *Method A:* Isolated azides could be introduced *via* a sample loop and pumped through a triphenylphosphine monolith to effect the Staudinger reaction. *Method B:* Alkyl azides were generated from the corresponding alkyl bromides and carried on to Staudinger reaction without isolation. *Method C:* Aryl azides were generated *in situ* from the corresponding anilines and carried on directly to Staudinger reaction.

elemental loading of phosphorous may not be identical to the functional loading due to the presence of triphenylphosphine oxide or triphenylphosphine not physically accessible for reaction.

Consequently, the substrates shown in Scheme 5 were used to explore the functional loading of these monoliths and the practicalities of achieving high conversion to the desired imines using these stoichiometric supported reagents. First, the Staudinger reaction was carried out (Scheme 4, Method C) using an excess (10 mmol) of 1-azido-4-methoxybenzene to ensure maximal loading of the desired iminophosphorane **3**. Next, the iminophosphorane monolith was reacted with 10 mmol of aldehyde **4**, recycling the reaction stream through the monolith for 20 h as shown in Scheme 5. This yielded 4.14 mmol of the imine product **5** (as a mixture with the unreacted aldehyde starting material, but in otherwise excellent purity). Elemental analysis of the depleted monolith indicated no residual nitrogen content, signifying that all of the iminophosphorane intermediate had been consumed

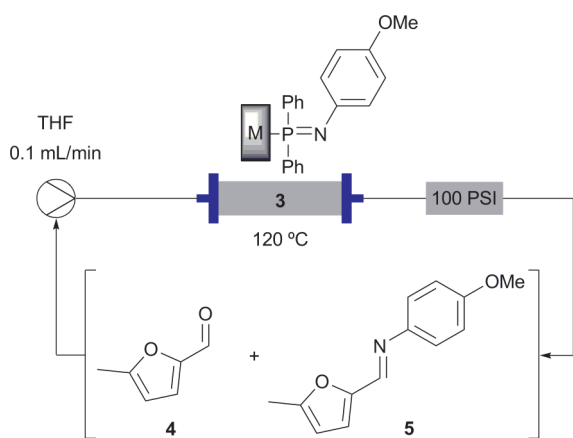

Scheme 5 Aza-Wittig reaction with recycling.

in the aza-Wittig reaction. For this combination of aza-Wittig partners, the active loading of the iminophosphorane monolith **3** was therefore 4.14 mmol.

In order to carry out multiple sequential aza-Wittig reactions, it is more practical to conduct each transformation in a single pass through the reactor. The aza-Wittig reaction shown in Scheme 5 was repeated in a single pass fashion at a flow rate of 0.1 mL min⁻¹. As expected, conversion steadily decreased as material was processed,²⁵ but reaction with the first 2 mmol of substrate could be carried out with good ($\geq 80\%$) conversion. Based on these findings, the aza-Wittig reactions shown in Table 2 were carried out using each iminophosphorane monolith to react with a maximum of 2 mmol of carbonyl partners (each reaction was run on 0.5–1 mmol scale).

The products were either directly isolated as imines following only evaporation of solvent, or reduced in batch by treatment with sodium borohydride, followed by purification of the desired amine *via* a catch-and-release protocol using polymer-supported sulfonic acid (QP-SA). In each case, the imines or resulting amines were obtained in high purities and generally high yields as shown in Table 2.

However, the Staudinger aza-Wittig reactions involving 1-azido-4-nitrobenzene (Table 2, Entries 24–26) proceeded with little or no conversion to the desired imines. Examination of the output stream from the Staudinger reaction step indicated successful reaction of 1-azido-4-nitrobenzene, suggesting that these poor conversions were due to the low reactivity of the resulting iminophosphorane intermediate in the aza-Wittig step.

The aza-Wittig reactions shown in Entries 17 and 20, on the other hand, proceeded with complete conversion. The resulting imines were isolated directly from the flow aza-Wittig process in excellent purity following only evaporation of solvent. These products were found to be free from cross-contamination and

Table 2 Staudinger aza-Wittig products

Entry	Azide	Aza-Wittig partner	Isolated product	Yield ^a
1				93%
2				95%
3				72%
4				81%
5				81%
6				73%
7				78%
8				98%
9				80%
10				80%
11				91%
12				Quant.

Table 2 (Contd.)

Entry	Azide	Aza-Wittig partner	Isolated product	Yield ^a
13				88%
14				97%
15				95%
16				62%
17				Quant.
18				94%
19				95% conversion 3 mmol scale ^b
20				Quant.
21				65%
22				Quant. 8 : 2 mixture E : Z

Table 2 (Contd.)

Entry	Azide	Aza-Wittig partner	Isolated product	Yield ^a
23			SM recovered	No reaction
24			SM recovered	No reaction ^c
25			SM recovered	No reaction ^c
26				51% conversion ^c

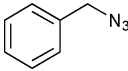
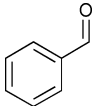
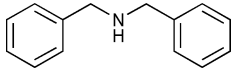
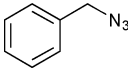
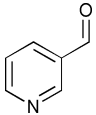
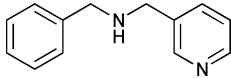
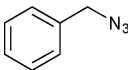
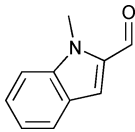
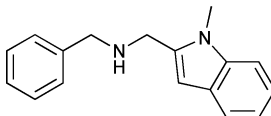
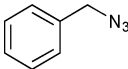
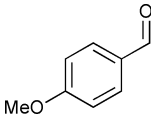
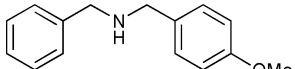
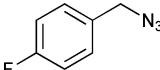
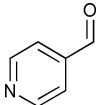
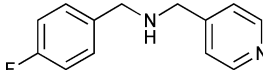
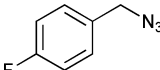
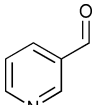
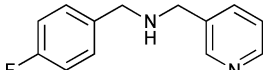
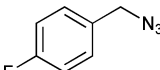
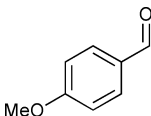
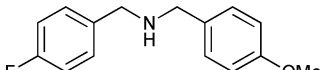
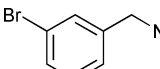
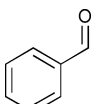
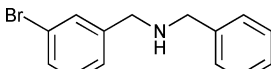
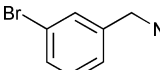
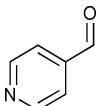
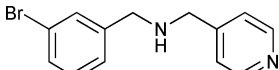
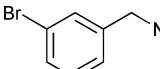
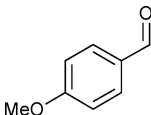
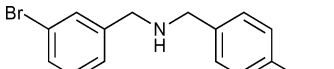
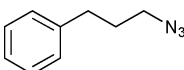
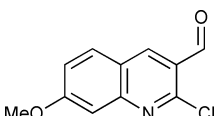
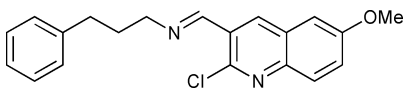
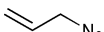
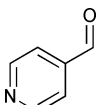
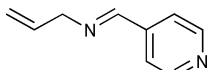
^a Aza-Wittig reactions were carried out on 0.5–1.0 mmol scale based on the starting aldehyde or ketone. Products shown as imines were isolated directly from the flow aza-Wittig reaction following only evaporation of solvent. For products shown as amines, the yield reported is the overall yield for the two step process of imine synthesis in flow followed by off-line reduction and purification by catch-and-release in batch. ^b 3 mmol of aldehyde starting material was recycled through the monolith for 4.5 h, resulting in 95% conversion to the desired imine as determined by ¹H NMR. ^c Examination of the waste stream from the Staudinger reaction step indicated successful loading of the desired iminophosphorane, however this intermediate proved unreactive with a number of aza-Wittig partners

≥95% pure by ¹H NMR, and confirmed by elemental analysis to be pure and free from phosphorous.

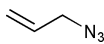
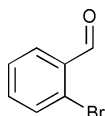
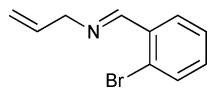
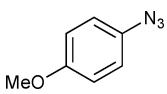
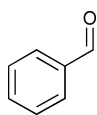
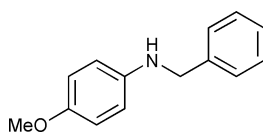
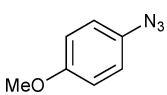
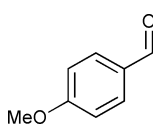
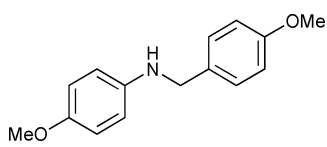
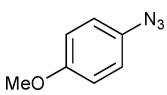
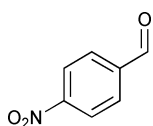
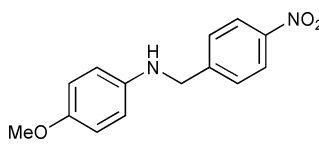
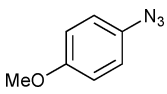
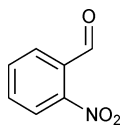
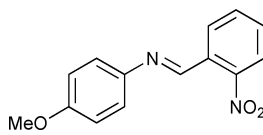
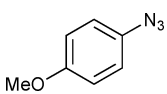
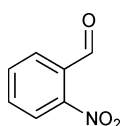
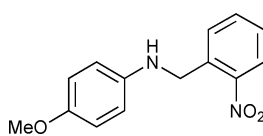
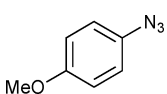
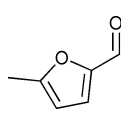
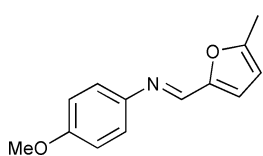
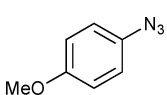
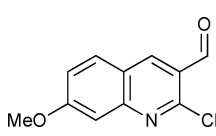
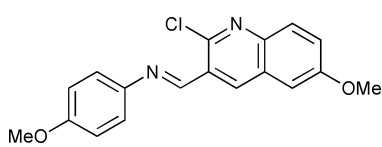
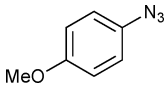
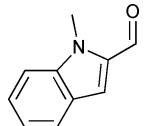
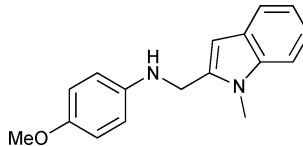
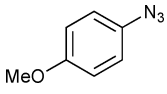
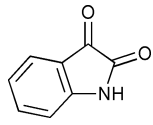
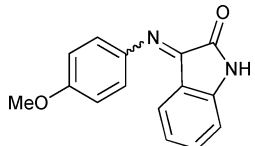
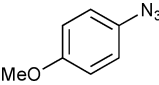
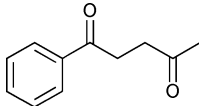
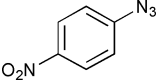
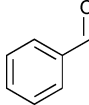
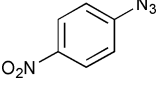
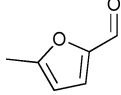
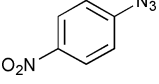
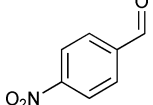
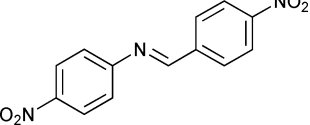
It was also found that larger scale aza-Wittig reactions could successfully be carried out with good conversion by recycling the reaction mixture to provide longer reaction time. The aza-Wittig reaction shown in Scheme 5 was repeated on a 3 mmol scale, recycling the reaction solution through the monolith for 4.5 h. As shown in Table 2, Entry 19, this resulted in 95% conversion to the desired imine as determined by ¹H NMR.

Automated multistep flow process for the generation of secondary amines

The multistep flow process described above gives access to imine products in high yields and purities, but imines are sensitive compounds, which are often prepared as synthetic intermediates for further reactions. It was therefore desirable to incorporate additional steps into the flow sequence, in order to use the imine intermediates in subsequent reactions without isolation. We chose to reduce the imines to the corresponding amines using a monolithic borohydride reagent (prepared by the same ion exchange procedure as for the azide monolith¹⁴). This reduction step and a subsequent in-line purification *via* catch-and-release were incorporated into the flow process following the aza-Wittig reaction.

Beginning with a pre-loaded iminophosphorane monolith (prepared by the flow process shown in Scheme 4), the full aza-Wittig, reduction and purification sequence shown in Scheme 6 was automated using Flow Commander software. In Step 1, aldehyde solutions (0.5 mmol, 0.5 M in THF) were injected into the flow system and pumped at 0.1 mL min⁻¹ through a pre-loaded

iminophosphorane monolith to carry out the aza-Wittig reaction. Upon exiting the iminophosphorane monolith, the flow stream was joined by a second stream of TFE at 0.1 mL min⁻¹.

The resulting solution was pumped at a combined flow rate of 0.2 mL min⁻¹ through the borohydride monolith, which was heated at 70 °C in the R4 convective heater. The presence of the more acidic TFE solvent was found to be very beneficial to the rate of the reduction step and the overall purity of the final products. Upon exiting the borohydride monolith, the solution passed through a column of QP-SA, trapping the desired amine product onto the solid phase and allowing any alcohol or other impurities to be washed to waste (Scheme 6, Step 1).

The clean amines were then released (Scheme 6, Step 2) using a solution of ammonia in methanol (2.0 M) at a flow rate of 0.5 mL min⁻¹, facilitating isolation of the desired products in good yields and purities following only evaporation of solvent as shown in Table 3.

An additional benefit of this in-line purification process is the option to make further use of the iminophosphorane monolith. By tolerating lower yields based on the aldehyde partner, this multistep sequence makes it possible to reclaim more of the iminophosphorane intermediate as clean final product. Despite reduced conversion to the imine intermediate as the iminophosphorane partner is consumed, the in-line reduction and purification protocol still gives access to amine products in consistently high purity. This is demonstrated by entries 4a–c in Table 3, which were carried out sequentially using the same iminophosphorane monolith: the yields decrease as the iminophosphorane monolith is depleted, but amine products are nevertheless obtained in excellent final purity.

Table 3 Amines synthesised using the automated aza-Wittig, reduction and purification sequence shown in Scheme 6

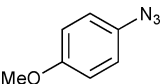
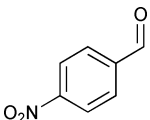
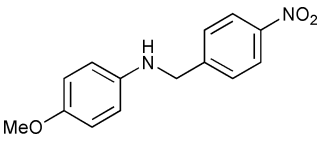
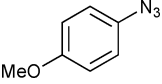
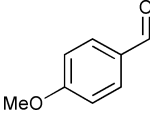
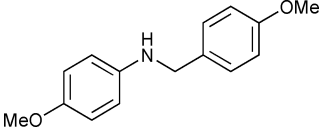
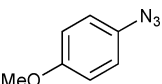
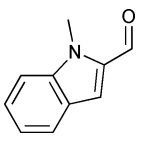
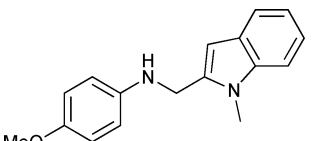
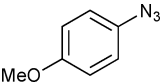
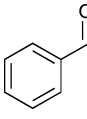
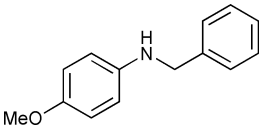
Entry	Azide	Aza-Wittig partner	Isolated product	Yield ^a
1				79%
2				77%
3				74%
4a ^b				88%
4b ^b				78%
4c ^b				68%

^a Reactions were carried out on 0.5 mmol scale based on the starting aldehyde. ^b These reactions were carried out sequentially using the same iminophosphorane monolith.

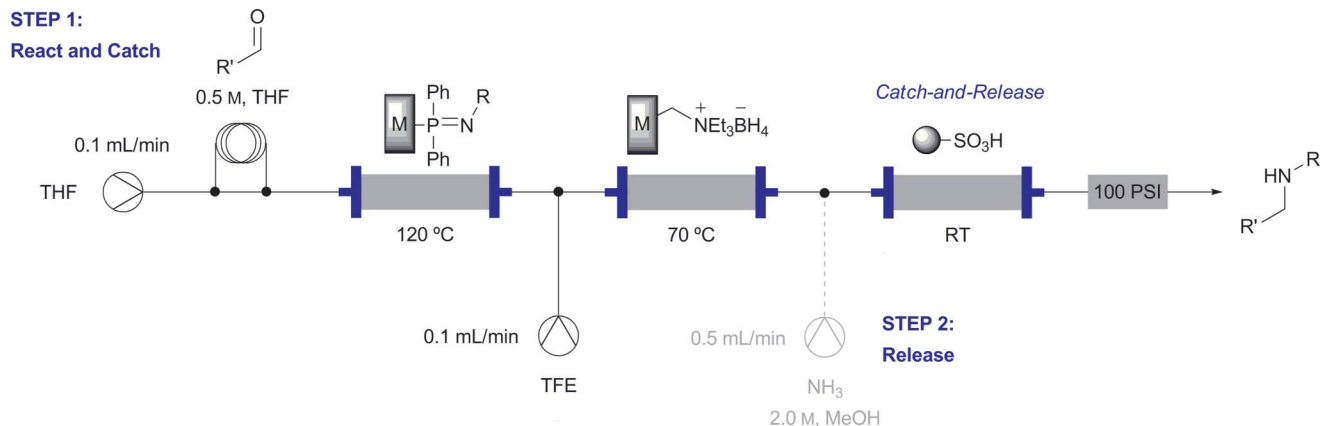

Scheme 6 Automated flow process for aza-Wittig reaction, imine reduction and purification. *Step 1*: Aldehyde partners were introduced *via* a sample loop, pumped through the iminophosphorane monolith (pre-loaded in a separate flow step as shown in Scheme 4) to effect aza-Wittig reaction, and the resulting imine intermediates reduced by passage through the borohydride monolith. Resulting amine products were trapped onto QP-SA, allowing any impurities to be washed to waste. *Step 2*: Amine products were released by washing with ammonia in methanol.

Conclusions

The generation and handling of organic azides normally involves a number of safety concerns, particularly on scale, which can limit the use of these important compounds. The flow procedures described here provide flexible working methods for the safe generation of a range of aryl and alkyl azides in high conversions. These compounds can either be isolated as final products or carried on directly to further transformations without isolation within a contained flow system.

The monolithic triphenylphosphine reagent described herein provides a new, improved and cost-effective format for this versatile reagent. Monolithic triphenylphosphine allows the facile use of triphenylphosphine in flow, to provide high purity products free from contamination with phosphine by-products without requiring any manual purification steps.

Finally, the application of these new reagents and techniques to the Staudinger aza-Wittig reaction enabled the synthesis of imine or amine products in good yields and purities from either alkyl bromide or aniline starting materials. This multistep flow

process, involving up to four reactions and two purification steps, requires no manual handling of the azide intermediates and no additional purification of the desired products. Using Vapourtec Flow Commander software, this sequence was successfully run in a highly automated fashion, and has the potential for application to fully automated library synthesis of imines and amines in flow.

Acknowledgements

We gratefully acknowledge Hokko Chemical Industry Co., Ltd. for their kind donation of styryl diphenylphosphine, Vapourtec for assistance in setting up the reactors, the Paul Mellon Fellowship (C. J. S.), Syngenta (C. D. S.), the EPSRC (N. N.), the Royal Society (I. R. B.) and the BP 1702 Fellowship (S. V. L.) for funding. We also wish to thank J. E. Davies for crystal structure determination and the EPSRC for a financial contribution toward the purchase of the X-ray diffractometer. We are grateful to P. C. Skelton, P. Grice and the Department of Chemistry NMR service for assistance with the mechanistic studies, and to the Department of Chemistry Photography Services for help with graphics.

Notes and references

- 1 L. Malet-Sanz, J. Madrzak, S. V. Ley and I. R. Baxendale, *Org. Biomol. Chem.*, 2010, **8**, 5324–5332; M. O'Brien, I. R. Baxendale and S. V. Ley, *Org. Lett.*, 2010, **12**, 1596–1598; X. Y. Mak, P. Laurino and P. H. Seeberger, *Beilstein J. Org. Chem.*, 2009, **5**, No. 19; T. Fukuyama, M. T. Rahman, M. Sato and I. Ryu, *Synlett*, 2008, 151–163; F. Benito-López, R. J. M. Egberink, D. N. Reinhoudt and W. Verboom, *Tetrahedron*, 2008, **64**, 10023–10040; C. Wiles and P. Watts, *Eur. J. Org. Chem.*, 2008, 1655–1671; J. Yoshida, A. Nagaki and T. Yamada, *Chem.–Eur. J.*, 2008, **14**, 7450–7459; *New Avenues to Efficient Chemical Synthesis: Emerging Technologies*, ed. P. H. Seeberger, and T. Blume, Springer, Berlin, 2007; I. R. Baxendale, J. J. Hayward and S. V. Ley, *Comb. Chem. High Throughput Screening*, 2007, **10**, 802–836; T. N. Glasnov and C. O. Kappe, *Macromol. Rapid Commun.*, 2007, **28**, 395–410; I. R. Baxendale and M. R. Pitts, *Chim. Oggi*, 2006, **24**, 41–45; A. Kirschning, W. Solodenko and K. Mennecke, *Chem.–Eur. J.*, 2006, **12**, 5972–5990; K. Jähnisch, V. Hessel, H. Löwe and M. Baerns, *Angew. Chem., Int. Ed.*, 2004, **43**, 406–446; P. Hodge, *Curr. Opin. Chem. Biol.*, 2003, **7**, 362–373.
- 2 C. H. Hornung, B. Hallmark, M. Baumann, I. R. Baxendale, S. V. Ley, P. Hester, P. Clayton and M. R. Mackley, *Ind. Eng. Chem. Res.*, 2010, **49**, 4576–4582; S. Hübner, U. Bentrup, U. Budde, K. Lovis, T. Dietrich, A. Freitag, L. Kupper and K. Jähnisch, *Org. Process Res. Dev.*, 2009, **13**, 952–960; A. A. Kulkarni, V. S. Kalyani, R. A. Joshi and R. R. Joshi, *Org. Process Res. Dev.*, 2009, **13**, 999–1002; A. Bogdan and D. T. McQuade, *Beilstein J. Org. Chem.*, 2009, **5**, No. 17; P. Styring and A. I. R. Parracho, *Beilstein J. Org. Chem.*, 2009, **5**, No. 29; U. Kunz and T. Turek, *Beilstein J. Org. Chem.*, 2009, **5**, No. 70; T. Gustafsson, F. Ponten and P. H. Seeberger, *Chem. Commun.*, 2008, 1100–1102; C. H. Hornung, M. R. Mackley, I. R. Baxendale and S. V. Ley, *Org. Process Res. Dev.*, 2007, **11**, 399–405; N. Steinfeldt, R. Abdallah, U. Dingerdissen and K. Jähnisch, *Org. Process Res. Dev.*, 2007, **11**, 1025–1031; I. R. Baxendale, C. M. Griffiths-Jones, S. V. Ley and G. K. Tranmer, *Chem.–Eur. J.*, 2006, **12**, 4407–4416; K. Jähnisch, V. Hessel, H. Löwe and M. Baerns, *Angew. Chem., Int. Ed.*, 2004, **43**, 406–446; A. J. deMello and R. Wootton, *Lab Chip*, 2002, **2**, 7N–13N; S. H. DeWitt, *Curr. Opin. Chem. Biol.*, 1999, **3**, 350–356.
- 3 J. Rolland, X. C. Cambeiro, C. Rodriguez-Escrich and M. A. Pericàs, *Beilstein J. Org. Chem.*, 2009, **5**, No. 56; P. H. Seeberger, *Nat. Chem.*, 2009, **1**, 258–260; A. Chighine, G. Sechi and M. Bradley, *Drug Discovery Today*, 2007, **12**, 459–464; A. Michrowska, K. Mennecke, U. Kunz, A. Kirschning and K. Grela, *J. Am. Chem. Soc.*, 2006, **128**, 13261–13267; A. Kirschning, and G. Jas, in *Immobilized Catalysts*, ed. A. Kirschning, Springer, Berlin, 2004, vol. 242, pp. 209–239; S. Bhattacharyya, *Curr. Opin. Drug Discovery Dev.*, 2004, **7**, 752–764; G. Jas and A. Kirschning, *Chem.–Eur. J.*, 2003, **9**, 5708–5723; S. V. Ley and I. R. Baxendale, *Nat. Rev. Drug Discovery*, 2002, **1**, 573–586; A. Kirschning, H. Monenschein and R. Wittenberg, *Angew. Chem., Int. Ed.*, 2001, **40**, 650–679; S. V. Ley, I. R. Baxendale, R. N. Bream, P. S. Jackson, A. G. Leach, D. A. Longbottom, M. Nesi, J. S. Scott, R. I. Storer and S. J. Taylor, *J. Chem. Soc., Perkin Trans. 1*, 2000, 3815–4195; D. C. Sherrington, *Chem. Commun.*, 1998, 2275–2286; S. J. Shuttleworth, P. M. Allin and K. Sharma, *Synthesis*, 1997, 1217–1239.
- 4 M. Brasholz, B. A. Johnson, J. M. Macdonald, A. Polyzos, J. Tsanaktisidis, S. Saubern, A. B. Holmes and J. H. Ryan, *Tetrahedron*, 2010, **66**, 6445–6449; M. Grafton, A. C. Mansfield and M. J. Fray, *Tetrahedron Lett.*, 2010, **51**, 1026–1029; L. Tamborini, P. Conti, A. Pinto and C. D. Micheli, *Tetrahedron: Asymmetry*, 2010, **21**, 222–225; A. R. Bogdan, S. L. Poe, D. C. Kubis, S. J. Broadwater and D. T. McQuade, *Angew. Chem., Int. Ed.*, 2009, **48**, 8547–8550; B. Ahmed-Omer, J. C. Brandt and T. Wirth, *Org. Biomol. Chem.*, 2007, **5**, 733–740; H. Sahoo, J. Kralj and K. Jensen, *Angew. Chem., Int. Ed.*, 2007, **46**, 5704–5708; M. Baumann, I. R. Baxendale, S. V. Ley, C. D. Smith and G. K. Tranmer, *Org. Lett.*, 2006, **8**, 5231–5234.
- 5 J. P. McMullen and K. F. Jensen, *Annu. Rev. Anal. Chem.*, 2010, **3**, 19–42; J. P. McMullen, M. T. Stone, S. L. Buchwald and K. F. Jensen, *Angew. Chem., Int. Ed.*, 2010, **49**, 7076–7080; S. V. Ley and I. R. Baxendale, *Chimia*, 2008, **62**, 162–168.
- 6 For illustrative examples see: I. R. Baxendale, S. Schou, J. Sedelmeier and S. V. Ley, *Chem.–Eur. J.*, 2010, **16**, 89–94; T. P. Petersen, A. Ritzén and T. Ulven, *Org. Lett.*, 2009, **11**, 5134–5137; For a more detailed discussion see: M. D. Hopkin, Ph.D. Thesis, University of Cambridge, 2010.
- 7 F. Stazi, D. Cancogni, L. Turco, P. Westerduin and S. Bacchi, *Tetrahedron Lett.*, 2010, **51**, 5385–5387.
- 8 Development of technology for the precise control of multistep segmented flow processes is currently underway in our laboratory, and will be reported in due course: H. Lange, C. F. Carter, M. D. Hopkin, A. Burke, J. G. Goode, I. R. Baxendale and S. V. Ley, *Chem. Sci.*, 2011, DOI: 10.1039/C0SC00603C.
- 9 M. D. Hopkin, I. R. Baxendale and S. V. Ley, *Chem. Commun.*, 2010, **46**, 2450–2452; Z. Qian, I. R. Baxendale and S. V. Ley, *Synlett*, 2010, 505–508; A. Palmieri, S. V. Ley, A. Polyzos, M. Ladlow and I. R. Baxendale, *Beilstein J. Org. Chem.*, 2009, **5**, No. 23; C. M. Griffiths-Jones, M. D. Hopkin, D. Jönsson, S. V. Ley, D. J. Tapolczay, E. Vickerstaffe and M. Ladlow, *J. Comb. Chem.*, 2007, **9**, 422–430; I. R. Baxendale, S. V. Ley, C. D. Smith and G. K. Tranmer, *Chem. Commun.*, 2006, 4835–4837; I. R. Baxendale and S. V. Ley, *Curr. Org. Chem.*, 2005, **9**, 1521–1534; Y. Suzuki and M. Kodomari, *Chem. Lett.*, 1998, **11**, 1091–1092; B. J. Cohen, M. A. Kraus and A. Patchornik, *J. Am. Chem. Soc.*, 1977, **99**, 4165–4167.
- 10 I. R. Baxendale, J. Deeley, C. M. Griffiths-Jones, S. V. Ley, S. Saaby and G. K. Tranmer, *Chem. Commun.*, 2006, 2566–2568.
- 11 H. Mahdavi and J. Amani, *Tetrahedron Lett.*, 2009, **50**, 5923–5926; C. Gil and S. Bräse, *Chem.–Eur. J.*, 2005, **11**, 2680–2688; A. Kamal, K. L. Reddy, V. Devaiah and N. Shankaraiah, *Synlett*, 2004, 2533–2536; B. J. Neubert and B. B. Snider, *Org. Lett.*, 2003, **5**, 765–768; A. Grieder and A. W. Thomas, *Synthesis*, 2003, 1707–1711; S. Barthélémy, S. Schneider and W. Bannwarth, *Tetrahedron Lett.*, 2002, **43**, 807–810; A. B. Charette, A. A. Boezio and M. K. Janes, *Org. Lett.*, 2000, **2**, 3777–3779; K. Hemming, M. J. Bevan, C. Loukou, S. D. Patel and D. Renaudeau, *Synlett*, 2000, 1565–1568.
- 12 C. H. Hornung, B. Hallmark, M. R. Mackley, I. R. Baxendale and S. V. Ley, *Adv. Synth. Catal.*, 2010, **352**, 1736–1745; N. T. S. Phan, J. Khan and P. Styring, *Tetrahedron*, 2005, **61**, 12065–12073; J. Siu, I. R. Baxendale, R. A. Lewthwaite and S. V. Ley, *Org. Biomol. Chem.*, 2005, **3**, 3140–3160; M. I. Burguete, E. Garcia-Verdugo, M. J. Vicent, S. V. Luis, H. Pennemann, N. Graf, von Keyserling and J. Martens, *Org. Lett.*, 2002, **4**, 3947–3950; A. M. Hafez, A. E. Taggi, T. Dudding and T. Lectka, *J. Am. Chem. Soc.*, 2001, **123**, 10853–10859; S. Laue, L. Greiner, J. Wöltinger and A. Liese, *Adv. Synth. Catal.*, 2001, **343**, 711–720.
- 13 N. Nikbin, M. Ladlow and S. V. Ley, *Org. Process Res. Dev.*, 2007, **11**, 458–462; F. Svec and C. G. Huber, *Anal. Chem.*, 2006, **78**, 2100–2107; B. Altava, M. I. Burguete, E. Garcia-Verdugo, S. V. Luis and M. J. Vicent, *Green Chem.*, 2006, **8**, 717–726; U. Kunz, H. Schönfeld, A. Kirschning and W. Solodenko, *J. Chromatogr. A*, 2003, **1006**, 241–249; W. Solodenko, U. Kunz, G. Jas and A. Kirschning, *Bioorg. Med. Chem. Lett.*, 2002, **12**, 1833–1835; A. Kirschning, C. Altwicker, G. Dräger, J. Harders, N. Hoffmann, U. Hoffmann, H. Schönfeld, W. Solodenko and U. Kunz, *Angew. Chem., Int. Ed.*, 2001, **40**, 3995–3998; J. A. Tripp, J. A. Stein, F. Svec and J. M. J. Fréchet, *Org. Lett.*, 2000, **2**, 195–198; E. C.

-
- Peters, F. Svec and J. M. J. Fréchet, *Adv. Mater.*, 1999, **11**, 1169–1181; C. Viklund, F. Svec, J. M. J. Fréchet and K. Irgum, *Chem. Mater.*, 1996, **8**, 744–750; F. Svec and J. M. J. Fréchet, *Chem. Mater.*, 1995, **7**, 707–715; Q. C. Wang, F. Svec and J. M. J. Fréchet, *Anal. Chem.*, 1995, **67**, 670–674; F. Svec and J. M. J. Fréchet, *Anal. Chem.*, 1992, **64**, 820–822.
- 14 M. Baumann, I. R. Baxendale, S. V. Ley, N. Nikbin and C. D. Smith, *Org. Biomol. Chem.*, 2008, **6**, 1587–1593.
- 15 Vapourtec R Series systems and Flow Commander™ software are available from VapourtecLtd, Park Farm Business Centre, Fornham St Genevieve, Bury St Edmunds, Suffolk, IP28 6TS, UK. Website: <http://www.vapourtec.co.uk>.
- 16 S. Bräse, C. Gil, K. Knepper and V. Zimmermann, *Angew. Chem., Int. Ed.*, 2005, **44**, 5188–5240.
- 17 I. R. Baxendale, S. V. Ley, A. C. Mansfield and C. D. Smith, *Angew. Chem., Int. Ed.*, 2009, **48**, 4017–4021; C. D. Smith, I. R. Baxendale, G. K. Tranmer, M. Baumann, S. C. Smith, R. A. Lewthwaite and S. V. Ley, *Org. Biomol. Chem.*, 2007, **5**, 1562–1568; C. D. Smith, I. R. Baxendale, S. Lanners, J. J. Hayward, S. C. Smith and S. V. Ley, *Org. Biomol. Chem.*, 2007, **5**, 1559–1561.
- 18 C. J. Smith, I. R. Baxendale, and S. V. Ley, ‘Forbidden’ Reactions in Flow: Azide Chemistry (PC-096), presented at the Eleventh International Kyoto Conference on New Aspects of Organic Chemistry, Kyoto, November, 2009.
- 19 K. Barral, A. D. Moorhouse and J. E. Moses, *Org. Lett.*, 2007, **9**, 1809–1811.
- 20 C. J. Smith, N. Nikbin, S. V. Ley, H. Lange and I. R. Baxendale, *Org. Biomol. Chem.*, 2011, DOI: 10.1039/c0ob00813c.
- 21 A. D. Moorhouse and J. E. Moses, *Synlett*, 2008, 2089–2092.
- 22 L. Malet-Sanz, J. Madrzak, R. S. Holvey and T. Underwood, *Tetrahedron Lett.*, 2009, **50**, 7263–7267 and references therein.
- 23 M. E. C. Biffin, J. Miller, and D. B. Paul, in *The Chemistry of the Azido Group*, ed. S. Patai, John Wiley & Sons, Ltd., London, 1971, pp. 156–165.
- 24 L. Lešetický, R. Barth, I. Nêmec, M. Štícha and I. Tišlerová, *Czech. J. Phys.*, 2003, **53**, A777–A782.
- 25 A graph of total cumulative conversion *versus* total material processed is included in the Supporting Information†.